

20
20

 **Beta**



€

40% off list price

**Promotion valid
until 31.12.2020**

Prices do not include V.A.T.

Beta

RSC55



3D
view



**Configure your
workshop on-line**

WWW.RSC55.COM

C55PB-PRO/5

Workbench, for workshop equipment combination comprised of:

C55PRO B0/2

Bench with worktop

2050x700 mm covered with a shockproof, non-scratch PVC coating, resistant to oil and hydrocarbons

- Holes for a vice (1599F/150, to be ordered separately)
- Vertically adjustable feet

C55C7

Mobile roller cab with seven drawers

- 588x367 mm with ball bearing slides
- 4 castors Ø 100 mm, 2 fixed (one with brake) and 2 steering
- Drawer bases protected by foamed rubber mats
- Front centralized lock

C55M7

Fixed module with seven drawers

- 588x367 mm with ball bearing slides
- Drawer bases protected by foamed rubber mats
- Front centralized lock

C55PS

Tool panel

- with shutter and framework
- Aluminium shutter, vertically adjustable, with lock, for tool protection
- Removable perforated panel for holding tools



C55M7

C55C7

C55PRO B0/2



Can be fitted with foam trays of the Beta range



Schuko socket +16+10A
EU Plug 16+10A



The steering wheels allow mobile roller cab C55C7 to be easily pulled out



Compressed air outlet and roller Ø 8 mm.
Length: 10 m

055000025	346 kg
€ 9.460,00	€ 5.676,00

A solution for every need...

Choose the roller cab which best fits your requirements!



	RAL 2011			RAL 7016			RAL 3000	
	800 x 1026 x 500 mm			740 x 955 x 445 mm			1050 x 973 x 565 mm	
	588 x 367 mm			588 x 367 mm			588 x 367 mm	
	6	7	8	6	7	8	7	7
70 mm - 30 kg	-	-	-	4	5	6	5	5
75 mm - 30 kg	4	5	6	-	-	-	-	-
140 mm - 35 kg	-	-	-	1	1	2	1	1
150 mm - 35 kg	1	1	2	-	-	-	-	-
210 mm - 35 kg	-	-	-	-	1	-	1	1
225 mm - 35 kg	-	1	-	-	-	-	-	-
280 mm - 35 kg	-	-	-	1	-	-	-	-
305 mm - 35 kg	1	-	-	-	-	-	-	-
	69 kg	71 kg	73 kg	55 kg	58 kg	61 kg	82 kg	80 kg

Certified quality

In 2018 Beta roller cabs were awarded prestigious TÜV certification, after passing severe tests according to protocol EK5/TA5.

Protocol EK5/TA5 deals with 31 well-defined building characteristics, stringent static tests and dynamic behaviour tests. Other tests determine resistance to high and low temperatures, the service life of markings over time and corrosion resistance.

Credit for this achievement is due to the expert design, accurate manufacture and stringent tests Beta relies on for its roller cabs, which has allowed their quality to be acknowledged by end users.



C37

Mobile roller cab

- Sturdy multi-purpose worktop.
- Convenient "V"-shaped groove for working pipes and sections.
- Quick release system made of aluminium, opening throughout length of drawer.
- Corner bumpers throughout height of roller cab, to avoid damaging vehicles in garage.
- Four castors Ø 125 mm:
2 fixed and 2 steering (one with brake).
- Static load capacity: 1000 kg.



Drawer bases protected by foamed rubber mats.



Built-in side bottle and paper holders, adjustable in several positions.



Tote-trays and holes for accommodating screwdrivers.



C37/6	037000061	037000062	037000063	€ 1.270,00	€ 762,00
C37/7	037000071	037000072	037000073	€ 1.305,00	€ 783,00
C37/8	037000081	037000082	037000083	€ 1.360,00	€ 816,00

C37A/7

Mobile roller cab with 7 drawers
With anti-tilt system



Anti-tilt system

New item



C37A/7	037000271	037000272	037000273	€ 1.405,00	€ 843,00
--------	-----------	-----------	-----------	------------	----------

3700/PLA

Stainless steel worktop

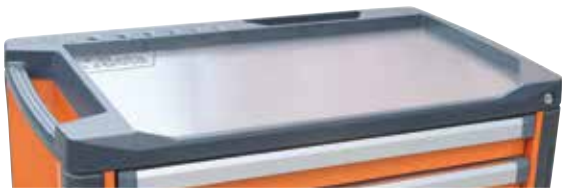

037000100 2,8 kg
~~€ 81,00~~ **€ 48,60** 672x396x1,5 mm

3700/PLL

Wood worktop



037000101 3,9 kg
~~€ 98,00~~ **€ 58,80** 672x396x28 mm

3700/PF

Perforated panel with brackets

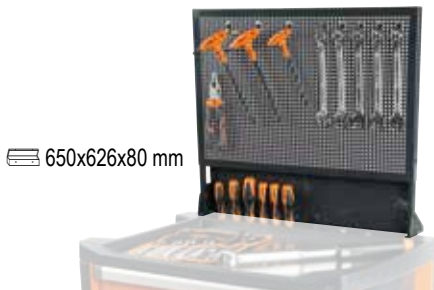

650x626x80 mm
 037000102 3,2 kg
~~€ 77,50~~ **€ 46,50**

3700/PFL

Perforated side panel



754x321x38 mm
 037000104 1,9 kg
~~€ 43,50~~ **€ 26,10**

3700/PC

Computer bracket



418x303x399 mm
 037000103 3,1 kg
~~€ 106,00~~ **€ 63,60**

C24S

Mobile roller cab

- Four castors with steel cores, Ø 125 mm: 2 fixed and 2 steering (one with brake)
- Front centralized safety lock
- Can accommodate paper roll holder item 2400S-R/PC, to be ordered separately



Pull-out drawer with quick release system made of fibreglass-reinforced nylon, opening throughout length of drawer



Sturdy ABS worktop

Built-in side bottle holder



C24S/6	024002061	024002062	024002063			€ 1.004,00 € 602,40
C24S/7	024002071	024002072	024002073	024002076	024002079	€ 1.030,00 € 618,00
C24S/8	024002081	024002082	024002083			€ 1.081,00 € 648,60

C24SL-CAB

Mobile roller cab with 7 drawers and tool cabinet

- Four castors with steel cores, Ø 125 mm: 2 fixed and 2 steering (with brakes)
- Front centralized lock

Multi-ply wood worktop with holes for a vice (1599F/100, to be ordered separately)



Side cabinet with vertically adjustable interior top and lockable door



Built-in paper roll holder
Double rear bottle holder



C24SL-CAB

024002191

024002192

024002193

€ 1.465,00

€ 879,00



C24SL

Mobile roller cab with 7 drawers and side tops

- 7 drawers (588x367 mm) with ball bearing slides:
 - 5 drawers, 70 mm high
 - 1 drawer, 140 mm high
 - 1 drawer, 210 mm high
- Drawer bases protected by foamed rubber mats
- Four castors 125 mm in Ø: 2 fixed and 2 steering (two with brakes)
- Front centralized safety lock
- Side compartment with vertically adjustable top
- Integrated paper roll holder
- Double rear bottle holder

Multi-ply wood worktop with holes for a vice (1599F/100, to be ordered separately)



C24SL

024002101

024002102

024002103

€ 1.645,00

€ 987,00



C56B

Workbench with wood top

Main features:

- Multi-ply wood worktop with holes for a vice (1599F/125, to be ordered separately)
- Steel frame with 4 supporting legs
- Lower object shelf
- Can be fixed to floor



62 kg

C56B 056000401 056000402 056000403 € 789,00 € 473,40



C58B

Workbench with wood top

Main features:

- Multi-ply wood worktop with holes for a vice (1599F/125, to be ordered separately)
- Steel frame with 4 supporting legs
- Lower object shelf
- Can be fixed to floor



59 kg

C58B 058000401 058000402 058000403 € 725,00 € 435,00



2054E/E-100



Tool case with assortment of 100 general maintenance tools



400x300x140 mm

020540020 7 kg € 632,50 € 316,25

860EA/31



861LP	0,5x3-0,6x4, 5-0,8x5,5-1,0x5,5-1,2x6,5-1,6x8 mm
861PH	PH1-PH2-PH3
861PZ	PZ1-PZ2-PZ3
861PE	2-3-4-5-6-8 mm
861TX	T8-T9-T10-T15-T20-T25-T27-T30-T40
861PQ	1-2-3 mm
882M1	1/4 - 1/4



882P/80	1/4 - 1/4
895 /1	1/4 - 1/4
C900	4-4,5-5-5,5-6-7-8-9-10-11-12-13-14 mm
C900/20	50 mm
C900/20L	100 mm
C900/25	
C900/30	150 mm
C900/42	110 mm
C900/48	

42C	6-7-8-9-10-11-12-13-14-15-16-17-19 mm
96K/SP9	1,5-2-2,5-3-4-5-6-8-10 mm
1048	250 mm
1082CM	160 mm
1150CM	180 mm
1166CM	160 mm
1201	3x75 - 5,5x100 - 6,5x150 mm
1202	PH0x60 - PH1x80 - PH2x100 mm
1253	3,5x100 mm
1370	300 g
1692/3	3 m
1770A	9 mm
1770RL	10x
1777BM	190 mm
1725CR	150 mm

C20L

Five-section cantilever tool box, made from sheet metal, empty



021200002 5,4 kg
€ 99,50 € 59,70

550x200x210 mm

C5

Rucksack, empty

- Removable interior tool panel
- Six exterior pockets and two interior pockets
- Waterproof plastic base
- Double safety lace for fixing rucksack to shoulders
- Ergonomic padded back



021050000 2,5 kg
€ 166,00 € 99,60

500x400x180 mm

2056E/E-20

1/4" 1/2"

Tool case with assortment of 163 general maintenance tools

- Removable tool panel
- Integrated thermoformed tool tray

New item



465x330x170 mm

020560111 8,4 kg
€ 765,63 € 390,63

1256/C21-1

1256LP	1,5-2-2,5 mm
1256PH	PH0-PH1
1256PZ	PZ0-PZ1
1256PE	0,7-0,9-1,3-1,5-2-2,5-3 mm
1256TX	T4-T5-T6-T7
1256RTX	T8-T10-T15
	4mm 99 mm



861/C61

861LP	0,5x3 (2)-0,5x4(2)-0,6x4,5(2)-0,8x5(2) 1,0x5,5(2)-1,0x6(2)-1,6x8(2) mm
861PH	PH0(2)-PH1(7)-PH2(7)-PH3(2)
861PZ	PZ0(2)-PZ1(3)-PZ2(3)-PZ3(2)
861PE	1,5-2-2,5-3-4-4,5-5-5,5-6-8 mm
861TX	T9-T10-T15-T20-T25 T27-T30-T40
	○ 1/4" ● 1/4"



1/4"	895 /1	⊗
	C900	○ 4-4,5-5-5,5-6-7-8-9-10-11-12-13-14 mm
	C900/20L	50 mm
	C900/20L	100 mm
	C900/25	
	C900/30	
	C900/42	110 mm
	C900/48	⊗

1/2"	C920A	○ 10-11-12-13-14-15-16-17-18-19-21-22-24 mm
	C920/21	125 mm
	C920/22	250 mm
	C910/16F	□ 3/8" - ■ 1/2"
	C920/25	
	C920/72	⊗

42C	⊗ 8-9-10-11-12-13-14-15-16-17-18-19 mm
96 BPC/SK9	○ 1,5-2-2,5-3-4-5-6-8-10 mm
111	250 mm
1048	250 mm
1128BMX	145 mm
1082CM	⊗ 160 mm
1150CM	≡ 180 mm
1166CM	● 160 mm
1201	● 2,5x50 - 3x75 - 4x125 - 5,5x150 - 6,5x150 - 8x150 mm
1202	⊗ PH1x80 - PH2x100 mm
1209PZ	⊗ PZ1x80 - PZ2x100 mm
1253	● 3,5x100 mm
1370	300 g
1692/5	5 m
1725CR	150 mm
1771	18 mm 3x



Assortment of tools
in thermoformed trays,
designed for roller cabs



C23ST C24S C24SA C24SA-XL C24SL C28 C30S C37 C39 C39T C39MD C39SM C57S C59 RSC55	1/4 2/3 1/2 1 1/3 M, T, VP
C22S C23S C23SC C27S	1/4 1 MC
C41S C41H	1 MC
C04TSS C38 C38T	1 M, T, VP
C45	1 MM
C35	1 MB

M10

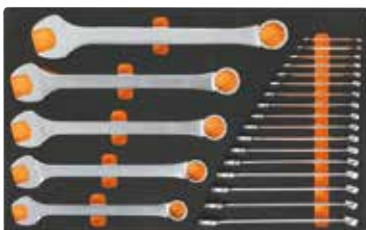

42 6-7-8-9-10-11-12-13-14-15-16-17-18-19-20-21-22-24-27-30-32-36 mm

024500010 4,5 kg
€ 481,00 € 288,60

M30



55 6x7-8x9-10x11-12x13-14x15-16x17-18x19-20x22-21x23-24x27-30x32 mm
90 6x7-8x9-10x11-12x13-14x15-16x17-18x19-20x22-21x23-24x27-30x32 mm
96BPC/SC9 1,5-2-2,5-3-4-5-6-8-10 mm

024500030 4,2 kg
€ 436,00 € 261,60

M60



96T 2-2,5-3-4-5-6-7-8-10 mm
97BTX/SC8 T9-T10-T15-T20-T25-T27-T30-T40
944BX 5-6-7-8-10-13 mm

024500060 1,9 kg
€ 422,00 € 253,20

M63



952 7-8-10-12-13-14-17-19 mm

024500063 3,4 kg
€ 390,00 € 234,00

M100

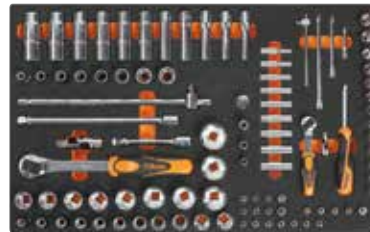

900/21 150 mm
900/25 - 900BG/30 - 900/42
900/55
920A 8-10-11-12-13-14-15-16-17-18-19-20-21-22-23-24-26-27-28-30-32 mm
920/15 - 920/25
920AN/125 125 mm
920AN/250 250 mm
920/42
920/55
920FTX 10-12-14-16-18-20-22-24 mm
920AL 10-12-13-14-15-16-17-18-19-21-22 mm

895/1 - 895/3 - 895/6
900 4-4,5-5-5,5-6-7-8-9-10-11-12-13-14 mm
900L 5-6-7-8-9-10-11-12-13 mm
900ME 3-4-5-6-7 mm
900LP 0,8x4-1x5,5-1,2x6,5-1,2x8 mm
900PH PH1-PH2-PH3-PH4
900TX T10-T15-T20-T25-T27-T30-T40
900/20 50 mm - 900/20L 100 mm

024500100 6,7 kg
€ 1.335,00 € 801,00

M105

12" 14" 38"



116

- 900 4-4,5-5-5,5-6-7-8-9-10
11-12-13-14 mm
- 900L 5-6-7-8-9-10-11-12-13 mm
- 96BPC/SC9 1,5-2-2,5-3-4-5-6-8-10 mm
- 895/1 - 895/3 - 895/6
- 900ME 3-4-5-6-7 mm
- 900LP 0,8x4-1x5,5-1,2x6,5-2x8 mm
- 900PH PH1-PH2-PH3-PH4
- 900TX T10-T15-T20-T25-T27-T30-T40
- 900/16 □ 1/4 - ■ 3/8
- 900/... 50-100-150 mm

900/25 - 900BG/30 - 900/42

⊕ 900/55

- 910A 6-7-8-9-10-11-12-13-14-15-16-17-18-19-20-21-22 mm

910/15 □ 3/8 - ■ 1/4

910/16 □ 3/8 - ■ 1/2

910/21 125 mm

910/22 250 mm

910/25 - 910/42

⊕ 910/55

- 920A 8-10-11-12-13-14-15-16-17-18-19-20-21-22-23-24-26-27-28-30-32 mm

920/15 □ 1/2 - ■ 3/8

920/25 125 - 250 mm

920AN 125 - 250 mm

920/42

⊕ 920/55

○ 956E 16-17,8-20,8 mm

024500871 7,7 kg

€ 1.455,00 € 873,00

M128

New item 12"



50

- 720 10-11-12-13-14-15-16-17-18-19-21-22-24-27-30-32 mm
- 720L 11-12-13-14-15-16-17-18-19-21-22-24-27-30-32 mm
- 720TX T30-T40-T45-T50-T55
- 720ME 5-6-8-10-12-14-17-19 mm
- 720LC 17-19-21 mm
- 720/21 125 mm
- 720/25

024500128 8,9 kg

€ 983,00 € 589,80

M195

New item

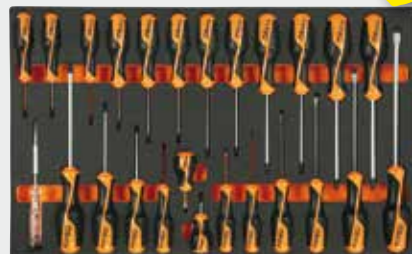

25

- 1260 2,5x50-3x75-4x100-5,5x125-6,5x150-8x200 mm
- 1260N 4x30 mm
- 1262 PH0x60-PH1x80-PH2x100-PH3x150 mm
- 1262 PH1X30 mm
- 1267TX T6-T7-T8-T9-T10-T15-T20-T25-T27-T30-T40-T45
- 1253 3,5x100 mm

024500195 2,3 kg

€ 350,00 € 210,00

M120

12"

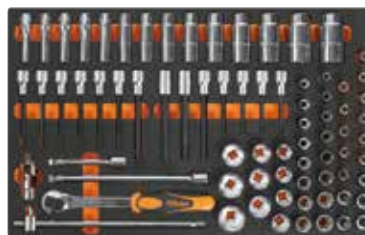

75

- 920A 10-11-12-13-14-15-16-17-18-19-20-21-22-24-26-27-30-32 mm
- 920AN/125 125 mm 920AN/250 250 mm
- 920/25 - 920/42
- 920AL 10-12-13-14-15-16-17-18-19-22-24-27-30-32 mm

○ 920FTX 10-12-14-16-18-20-22-24 mm

⊕ 920/55

○ 920PE 5-5L-6-6L-7-7L-8-8L-10-10L-12-12L-14-14L

○ 920TX T20-T25-T27-T30-T40-T45-T50-T55-T60-T20L-T25L-T27L-T30L-T40L-T45L-T50L

024500120 6,9 kg

€ 1.410,00 € 846,00

M130

13



- 1032 180 mm
- 1034 170 mm
- 1036 175 mm
- 1038 175 mm
- 1048 250 mm
- 1052 240 mm
- ⚡ 1082BM 160 mm
- 1098 220 mm
- 1112 250 mm
- 1128BM
- 1150BM 180 mm
- 1166BM 160 mm
- 1168BM 160 mm

024500130 3,4 kg

€ 470,00 € 282,00

M210

25



- 1201 2,5x50-3x75-4x100-5,5x125-6,5x150-8x200 mm
- 1201N 4x30 mm
- 1202 PH0x60-PH1x80-PH2x100-PH3x150 mm
- 1202N PH1X30 mm
- 1207TX T6-T7-T8-T9-T10-T15-T20-T25-T27-T30-T40-T45
- 1253

024500210 1,8 kg

€ 216,50 € 129,90

M230

25



- 30 Ø 2-3-4 mm
- 31 Ø 2-3-4-5-6-8 mm
- 32 Ø 4 mm
- 34 150 mm
- 35 200-250 mm
- 36 125 mm
- 1370 500 g
- 1390 Ø 35 mm
- 1692 3 m
- 1712
- 1719BMA/Q 200 mm
- ▲ 1719BMA/T 200 mm
- 1719BMA/P 200 mm
- ▶ 1719BMA/M 200 mm
- 1719BMA/R 200 mm
- 1737
- 1771 18 mm

024500230 3,2 kg

€ 470,00 € 282,00

42/SC9

Set of 9 combination wrenches

- compact, practical, easy-to-carry support
- quickly identifiable wrench size
- wrench safely locked in support

8-10-11-12-13-14-15-17-19 mm



NEW DESIGN

000421087 890 g

€ 120,00 € 72,00

42/SP15

Set of 15 combination wrenches with holder



NEW DESIGN



6-7-8-9-10-11-12-13
14-15-16-17-19-22-24 mm

000421078 2,1 kg

€ 199,00 € 119,40

142/SC9

Set of 9 reversible ratcheting combination wrenches, with compact support

8-10-11-12-13-14-15-17-19 mm



001420087 1,2 kg

€ 246,00 € 147,60

142SN/SC9

Set of 9 swivel end ratcheting combination wrenches with compact support

8-10-11-12-13-14-15-17-19 mm



001420259 1,3 kg

€ 293,00 € 175,80

55/SP7

Set of 7 double open end wrenches with holder

6x7-8x9-10x11-12x13
14x15-16x17-18x19 mm



000550167 920 g

€ 66,00 € 39,60

90/S7

Set of 7 double ended deep offset ring wrenches

6x7-8x9-10x11-12x13-14x15
16x17-18x19 mm



000900163 800 g

€ 95,50 € 57,30

111

Adjustable wrenches with scales, chrome-plated

- Movable jaw opening with right-hand rotation of pin
- Head angled at 22.5 degrees, with mm and inch scale



	L mm	A max	g			
111/100	100	15 mm	60	001110010	€ 23,10	€ 13,86
111/150	150	24 mm	165	001110015	€ 23,80	€ 14,28
111/200	200	28 mm	325	001110020	€ 30,50	€ 18,30
111/250	250	34 mm	505	001110025	€ 38,50	€ 23,10
111/300	300	35 mm	790	001110030	€ 48,50	€ 29,10
111/450	450	54 mm	2043	001110045	€ 172,50	€ 103,50
111/600	600	62 mm	3300	001110060	€ 234,50	€ 140,70

*mm/inch
readout*

944BX/D6

Set of 6 deep, hi-torque hexagon nut spinners long series

- 5-6-7-8-10-13 mm



Betamax



009440056 1 kg
€ 147,00 € 88,20

96T/S5P

Set of 5 offset hexagon key wrenches with handles

- 2,5-3-4-5-6 mm



000960946 300 g
€ 70,00 € 42,00

97TTX/S6

Set of 6 ball head offset key wrenches for Torx® head screws with handles

- T10-T15-T20-T25-T30-T40



000970791 400 g
€ 102,50 € 61,50

951/S6

Set of 6 T-handle wrenches with three hexagon male ends

- 2,5-3-4-5-6-8 mm



009510687 600 g
€ 152,50 € 91,50

952/D7

Set of 7 T-handle wrenches with swivelling hexagon sockets

- 7-8-10-12-13-14-17 mm

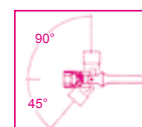

009520079 2,5 kg
€ 279,00 € 167,40

96/SC9

Set of 9 offset hexagon key wrenches Chrome plated



Ø mm	L mm
1,5	42
2	48
2,5	59
3	62
4	70
5	81
6	92
8	102
10	116

000960374 300 g
~~€ 22,10~~ € 13,26

96BP-CL/SC9

Set of 9 ball head offset hexagon key wrenches, coloured



Ø mm	L mm
1,5	91
2	100
2,5	113
3	130
4	142
5	163
6	185
8	205
10	231



000961619 440 g
~~€ 41,00~~ € 24,60

96BPC/SC9

Set of 9 ball head offset hexagon key wrenches Chrome plated



Ø mm	L mm
1,5	79
2	85
2,5	89
3	100
4	110
5	129
6	152
8	173
10	194

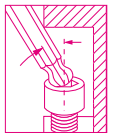

000960354 400 g
~~€ 42,50~~ € 25,50

97BTXL/SC8

Set of 8 ball head offset key wrenches, long model, for Torx® head screws



Ø mm	L mm
T9	83
T10	89
T15	103
T20	114
T25	130
T27	145
T30	166
T40	183



000970364 240 g
~~€ 76,50~~ € 45,90

97BTX/SC8

Set of 8 ball head offset key wrenches, for Torx® head screws



Ø mm	L mm
T9	65
T10	74
T15	84
T20	96
T25	98
T27	109
T30	123
T40	136



000970164 170 g
~~€ 83,50~~ € 50,10

96LBP/SC9

Set of 9 ball head offset hexagon key wrenches Chrome plated



Ø mm	L mm
1,5	91
2	100
2,5	113
3	130
4	142
5	163
6	185
8	205
10	231

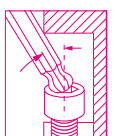

000961354 500 g
~~€ 34,00~~ € 20,40

861PB

New item 1/4

Set of 6 bits in fabric bracelet with magnetic clasp

Magnetic bit holder



Allows bit to be changed with one hand

MIX1

- ⊕ 861PH PH1 - PH2
- ⊕ 861PZ PZ1 - PZ2
- 861PE 4 - 5 mm



008610956 61 g
~~€ 44,50~~ € 26,70

MIX2

- ⊕ 861PH PH2
- ⊕ 861PZ PZ2
- 861TX TX20 - TX25
TX30 - TX40



008610966 61 g
~~€ 45,50~~ € 27,30

860MIX/A10

1/4

Set of 10 bits with magnetic bit holder, in plastic case

- 860LP 0,5x3-1,0x5,5-1,2x6,5 mm
- ⊕ 860PH PH1-PH2 (x2)-PH3
- ⊕ 860PZ PZ1-PZ2-PZ3
- 882M1 ○ 1/4" - ● 1/4"



008600900 130 g
~~€ 31,00~~ € 18,60



860/C27

1/4

Set of 25 bits, 1 connector and 1 reversible ratchet in plastic case



- 860LP 0,5x3-1,0x5,5-1,2x6,5 mm
- 860PE 2-2,5-3-4-5-6-mm
- ⊕ 860PH PH1-PH2(x2)-PH3
- ⊕ 860TX T6-T8-T10-T15-T20-T25-T30-T40
- ⊕ 860PZ PZ1 - PZ2(2x) - PZ3
- 860/55 100 mm
- 892/0



008600880 320 g
~~€ 97,00~~ € 58,20

860MIX/A31

1/4

Set of 30 bits with magnetic bit holder in plastic case

- 860LP 0,5x3 - 0,6x4,5 - 0,8x5,5
1,0x5,5 - 1,2x6,5 mm
- 860PE 2-2,5-3-4-5-6-8-10 mm
- ⊕ 860PH PH0 - PH1 - PH2 - PH3 - PH4
- ⊕ 860RTX T9-T10-T15-T20-T25-T27-T30-T40
- ⊕ 860PZ PZ1 - PZ2 - PZ3 - PZ4
- 882MSR/50 ○ 1/4 ● 1/4



008600902 320 g
~~€ 94,00~~ € 56,40

860TX/A10

1/4

Set of 10 bits with magnetic bit holder, in plastic case

- ⊕ 860TX T7-T8-T9-T10-T15-T20
T25-T27-T30-T40
- 882M1 ○ 1/4 ● 1/4



008600970 130 g
~~€ 35,00~~ € 21,00

862F/A7

1/4

Set of 7 magnetic bits, hexagon sockets, in plastic case

- 862F ○ 5,5-6-7-8-10-12-13 mm



008620950 350 g
~~€ 51,50~~ € 30,90

1203/D8P

Set of 8 screwdrivers

- 1201 2,5x50-3x75-4x100-5,5x100
6,5x150 mm
- 1202 PH0x60-PH1x80
PH2x100 mm



1203/D10N

Set of 10 screwdrivers

- 1201 2,5x50-3x75-4x100-5,5x150
6,5x150 mm
- 1202 PH0x60-PH1x80- PH2x100 mm
- 1201N 4x30 mm
- 1202N PH1x30 mm



1207TX/D7

Set of 7 screwdrivers

- 1207TX T6-T8-T10-T15
T20-T25-T30



012030018	640 g
€ 44,50	€ 26,70

012030019	740 g
€ 58,00	€ 34,80

012070207	560 g
€ 53,00	€ 31,80

12" 14" 3/8"

Reversible ratchet



	L mm	Ø mm	A mm	■	g			
900/55	125	25	18	1/4"	90	009000870	€ 55,50	€ 33,30
910/55	200	30	33	3/8"	239	009100882	€ 65,50	€ 39,30
920/55	275	40	43	1/2"	475	009200882	€ 85,00	€ 51,00

12" 14" 3/8"

Reversible ratchet with rotating handle

- Ring nut reversal system on ratchet head
- Bi-material handle

Rotating the handle clockwise and anticlockwise will make the bit turn quickly



Socket release button

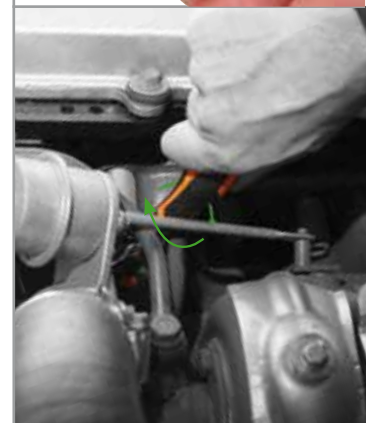

	L mm	Ø mm	A mm	■	g			
900/58	126	28	28,5	1/4"	155	009000884	€ 91,00	€ 54,60
910/58	222	37	38,5	3/8"	417	009100884	€ 103,00	€ 61,80
920/58	281	42,5	45	1/2"	705	009200926	€ 115,50	€ 69,30



Assortment of 11 hexagon sockets, 21 bits and 7 accessories in plastic case



	861LP	● 0,6x4,5-1,2x6,5-1,2x8 mm
	861PE	○ 2,5-3-4-5-6 mm
	861PH	⊕ PH1-PH2-PH3
	861PZ	⊕ PZ1-PZ2-PZ3
	861RTX	⊕ T10-T15-T20-T25-T27-T30-T40 mm
	892/0	● 1/4" - ■ 1/4"
	895/1	○ 1/4" - □ 1/4"
	900	○ 5-5,5-6-7-8-9-10-11-12-13-14 mm
	900/20	50 mm
	900/20L	100 mm
	900/25	
	900BG/30C	128 mm

900/C39

reversible ratchet (900/55)

009000937 785 g

€ 202,00 € 121,20



900/C39-R

reversible ratchet with rotating handle (900/58)

009000938 840 g

€ 241,00 € 144,60



900/C12MR

Assortment of 12 hexagon sockets, 20 bits and 7 accessories, in metal case



009000962 1,3 kg

€ 273,00 € 163,80

350x150x50 mm

	861LP	● 0,5x3-0,8x5,5-1x5,5-1,2x6,5 mm
	861PE	○ 3-4-5-6-8 mm
	861PH	⊕ PH0-PH1-PH2-PH3
	861TX	⊕ T8-T10-T15-T20-T25-T30-T40
	895/1	○ 1/4" - □ 1/4"
	900	○ 4-5-5,5-6-7-8-9-10-11-12-13-14 mm
	900/20	50 mm
	900/21	150 mm
	900/25	
	900/42	115 mm
	900BG/30	128 mm
	900/58	

910A/C16HR

Assortment of 16 hexagon sockets and 5 accessories in foam tray, in metal case



009100935 2,4 kg

€ 358,00 € 214,80

335x145x60 mm

	910A	○ 6-7-8-9-10-11-12-13-14-15-16-17-18-19-21-22 mm
	910/21	125 mm
	910/22	250 mm
	910/25	
	910/42	210 mm
	900/58	

920A/C17MR

Assortment of 17 hexagon sockets and 5 accessories in foam tray, in metal case



009200937 5,1 kg

€ 405,00 € 243,00

420x185x60 mm

	920A	○ 10-11-12-13-14-15-16-17-18-19-20-21-22-24-27-30-32 mm
	920/21	125 mm
	920/22	255 mm
	920/25	
	920/42	305 mm
	920/58	

605E

14"

Click-type torque wrenches with reversible ratchets for right-hand and left-hand tightening torque accuracy: $\pm 6\%$



	Nm	kgfm	lbf.in	■	L (mm)	g		UNI EN 26789 ISO 6789	
605E/5	1÷5	0,1÷0,5	10÷45	1/4"	190	180	006050105	€ 243,50	€ 146,10
605E/10	2÷10	0,2÷1,0	18÷90	1/4"	190	180	006050110	€ 257,00	€ 154,20

665

MADE IN ITALY

38" 12"

Mechanical torque wrench with digital setting and reversible ratchet, for right-hand tightening, torque accuracy $\pm 3\%$

- Auto power off after 10" when torque is set under minimum torque threshold
- Display will remain on with set torque value
- Torque setting to decimal digit
- Power supply: 1 battery 3V (included)

665/SW

Digital torque calibration device
Device allows calibration of wrenches item 665 with help of torque meters 680 and 682, without having to dismantle wrench. Fitted with a micro USB port, for firmware updates.



006650100	40 g
€ 26,00	€ 15,60

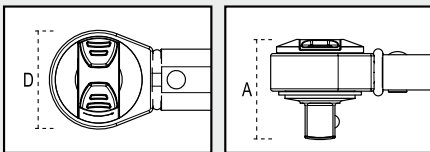

Quick, accurate digital torque adjustment

	Nm	■	D (mm)	A (mm)	L (mm)	g		UNI EN 26789 ISO 6789	
665/6	10÷60	3/8	30	33	335	655	006650006	€ 281,00	€ 168,60
665/10	20÷100	3/8	30	33	375	725	006650010	€ 287,00	€ 172,20
665/10X	20÷100	1/2	30	37	375	725	006650011	€ 290,00	€ 174,00
665/20	40÷200	1/2	40	43	470	995	006650020	€ 315,00	€ 189,00
665/30	60÷330	1/2	40	43	590	1260	006650030	€ 367,00	€ 220,20



677/C

34"

Break-back torque wrenches with push-through ratchets, for right-hand and left-hand tightening, torque accuracy: $\pm 4\%$, in case



	Nm	kgfm	lbf.ft	■	L (mm)	kg		UNI EN 26789 ISO 6789	
677/C50	100÷500	10÷50	70÷350	3/4"	915	5,2	006770606	€ 1.052,00	€ 631,20
677/C70	150÷700	15÷70	100÷500	3/4"	1140	6,2	006770611	€ 1.099,00	€ 659,40
677/C100	300÷1000	30÷100	200÷750	3/4"	1470	7,5	006770615	€ 1.350,00	€ 810,00

1169/D4

Set of 4 pliers.
1 combination, 1 long
needle nose, 1 cutting nipper
and 1 slip joint with boxed joints.



1082 160 mm 1150 180 mm 1166 160 mm 1048 250 mm

011690004 1,1 kg
€124,00 €74,40



1169BM/D3

Set of 1 combination pliers, 1 long needle nose
pliers and 1 diagonal cutting nippers



1082BM 160 mm

1150BM 180 mm

1166BM 160 mm

011690123 700 g
€111,50 €66,90

1150HPC

Heavy duty combination pliers with integrated
cutting edges and decentralized pin
Matt chrome-plated finish,
bi-material handles, open joint

Hardness of M2 steel cutting edges = **65HRC**

Shearing stress - static test = **-73%**

Average life of cutting edges
(test ISO 5744) = **+127%**

**MATT
CHROME-PLATED
FINISH**

**• ABSOLUTELY
GROUNDBREAKING
• REMARKABLE CUTTING
CAPACITY**



180 mm

**CUTTING EDGE
HARDNESS:
65HRC**

MADE IN ITALY

011500618 290 g
€73,50 €44,10

**PATENT
PENDING**

1031/S4

Set of 4 circlip pliers



1034 170 mm
⊙ 19 ÷ 60 mm

1032 180 mm
⊙ 19 ÷ 60 mm

1036 175 mm
● 19 ÷ 60 mm

1038 175 mm
● 19 ÷ 60 mm

010310000 650 g
€111,50 €66,90



31BM/D6

Set of 6 pin punches with handles

Ø 2-3-4-5-6-8 mm

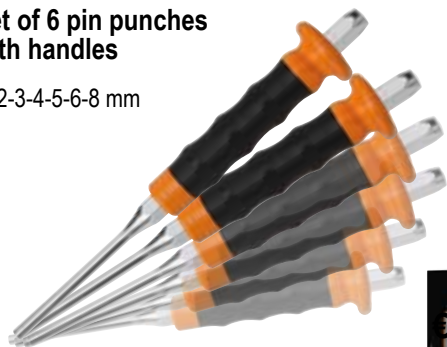

000310420 805 g
~~€ 136,00~~ € 81,60

ZUK35B5SE

New Item

Contains flat chisels, ribbed type

35 100 mm
 35 125 mm
 35 150 mm
 35 200 mm
 35 250 mm



ZUK35B5SE 1 kg
~~€ 145,88~~ € 87,53

1377T

Ball pein hammers, round heads, for coppersmiths and tinsmiths, fibre shafts



	g	L1 mm			
1377 340	340	95	013770534	€ 31,00	€ 18,60
1377 450	450	102	013770545	€ 37,00	€ 22,20
1377 570	570	110	013770557	€ 41,50	€ 24,90
1377 680	680	116	013770568	€ 45,00	€ 27,00
1377 900	900	120	013770590	€ 51,00	€ 30,60

412M/SP19

Set of 19 twist drills with cylindrical shanks, HSS, AISI M2, entirely ground finishing

- Self-centring
- High performance and cutting accuracy
- For drilling alloy steel, cast iron and metal in general

Ø 1÷10 x 0,5 mm
 R ≤ 850 N/mm²
 HV ≈ 820
 DIN 338



004120469 590 g
~~€ 95,50~~ € 57,30

415CO/SP19A

Twist drills with cylindrical shanks, HSS-CO 5%

- For drilling holes into STAINLESS steel, alloy steel, cast iron, mild steel, light alloys

Ø 1÷10 x 0,5 mm
 R ≤ 1400 N/mm²
 HV ≈ 850÷920
 DIN 338



004150440 590 g
~~€ 158,00~~ € 94,80

437U/09

Assortment for repairing damaged threads

004370550 2 kg
~~€ 420,00~~ € 252,00



M5X0,8
 M6X1,0
 M8X1,25
 M10X1,5
 M12X1,75

370x230x55 mm

1128FXS

Electrician's scissors with graduated milling profiles, straight stainless steel blades, with microteeth, cable cutting groove and crimping pliers for tube terminals

- Articulated belt hook case
- Bimaterial handles
- Anti-loose pin
- Profile and mill: designed to enlarge holes on plastic, from 13 to 21 mm



New item

Patented

A new perspective

To redesign our electrician's scissors, we observed users' daily work. We have made it into a universal tool, incorporating the 4 main features into one object.

CUTTING

quick and sharp, for cables up to 50 mm², with a cable cutting groove and a microtoothed blade, for improved hold.

STRIPPING

the sensitive anti-loosening pin allows even the thinnest cables to be accurately stripped.

CRIMPING

safe and durable, for tube terminals.

COUNTERSINKING

the unique milling profile allows the holes in pull boxes to be countersunk accurately and neatly.

011280095

80 g

~~€ 35,50~~

€ 21,30

1128BAX

Double-acting electricians' scissors, with milling profiles in DLC-coated stainless steel

- High blade surface hardness (resistance to abrasion and wear)
- Low coefficient of friction (smoothness and anti-adherence)
- With articulated plastic case



**+hardness
-coefficient
of friction**



Profile and mill: designed to enlarge holes on plastic, from 13 mm to 25 mm.

Patented

011280088

160 g

~~€ 35,50~~

€ 21,30

1778SOS

Car service knife with window breaking hammer and seat belt cutter features, in case

- with clip and fabric wallet with loop
- anodized aluminium handle
- safety blade lock



017780080

184 g

~~€ 35,00~~

€ 21,00

1772M

Safety utility knife with retractable blade, supplied with 3 blades

- Blade retracts through an automatic spring mechanism
- die-cast alloy body
- staple remover built into handle



Adjustable cutting depth $\varnothing \div 25$ mm

017720040

160 g

~~€ 23,50~~

€ 14,10

1771HD **New item**

Utility knife, 18 mm, supplied with 6 blades

- Automatic blade change
- Screw blade locking system



017710100

170 g

~~€ 26,00~~

€ 15,60

1691BM

Measuring tapes shock-resistant bimaterial ABS casings, steel tapes, precision class: II



	L (m)	S(mm)	W (g)	Icon	€	€
1691BM/5	5	25	275		€11,40	€ 6,84
1691BM/8	8	32	490		€22,10	€ 13,26
1691BM/10	10	32	630		€28,00	€ 16,80

1500N

Universal pullers with 2 sliding legs

	A min (mm)	A max (mm)	L (mm)	Icon	€	€
1500N/0	18	65	70		€76,50	€ 45,90
1500N/1	23	70	100		€76,50	€ 45,90
1500N/2	23	100	100		€78,00	€ 46,80
1500N/3	35	140	150		€134,50	€ 80,70
1500N/4	35	190	150		€143,50	€ 86,10
1500N/5	43	250	205		€285,00	€ 171,00
1500N/6	43	320	205		€304,00	€ 182,40

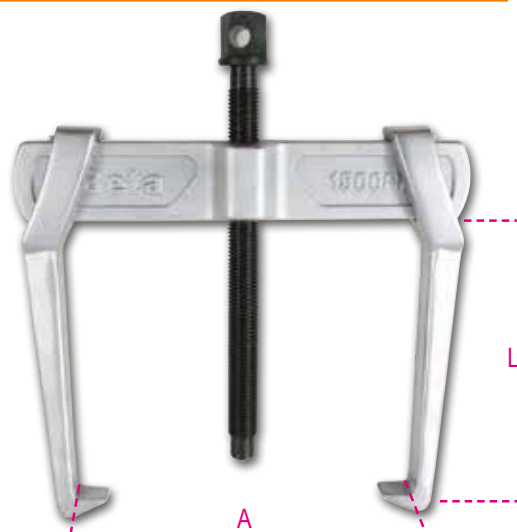

437P

Thread dresser, for repairing internal and external, right-hand and left-hand threads
P 0,80÷3,00 mm

New item



	004370003	122 g
€55,50	€ 33,30	

363

Heavy duty pipe wrenches made from light alloy



	L (m)	Ø (")	Ø (mm)	Icon	€	€
363 350	350	2" gas	60		€75,00	€ 45,00
363 450	450	2 1/2" gas	76		€103,00	€ 61,80
363 600	600	3" gas	90		€173,50	€ 104,10
363 900	900	5" gas	140		€325,00	€ 195,00

1149F

Front wire stripping pliers with cutting blade, self-adjusting

0,2÷6 mm²



011490010 500 g
~~€ 21,00~~ € 12,60

1740B 330

Compact heavy-duty riveting pliers

- Optimized lever ratio for increased compactness and handiness.
- 3 jaws lock rivet for a perfect grip.
- Adjustable head for pulling rivet by 2 to 5 leg movements.

2,4÷6,4 mm steel



*3 jaws:
improved
rivet grip*

017400330 1 kg
~~€ 90,50~~ € 54,30



*With
stem
tank*

1741B

Riveting pliers supplied with 4 interchangeable nozzles



017410000 600 g
~~€ 49,50~~ € 29,70

1741U

Ultra compact riveting pliers with adjustable force with 4 interchangeable nozzles
3 legs: enhanced rivet hold



*3 jaws:
improved
rivet grip*

017410450 450 g
~~€ 55,00~~ € 33,00



L 200 mm

Beta ABRASIVES

free grinder



Free Metabo 900W Angle Grinder worth over € 50.85 when you buy a mix of 500 X 11034 Beta 1mm or 1.6mm cutting discs

New item

11011

Abrasive steel grinding discs with depressed centre
• S = 6,5 mm



Ø mm		€ 2,50	€ 1,50
115	110110115		
230	110110230	€ 6,75	€ 4,05

11034

Abrasive steel and stainless steel cutting discs, thin, with flat centre – Top Line



S mm		€ 2,00	€ 1,20
1	110340022		
1,6	110340062	€ 2,00	€ 1,20

11035

Abrasive steel and stainless steel cutting discs, thin, with flat centre – Top Line



S mm		€ 2,25	€ 1,35
1	110350022		
1,6	110350062	€ 2,25	€ 1,35

11038

Abrasive steel and stainless steel cutting discs, thin, with flat centre – Top Line



	110380022	€ 4,25	€ 2,55
--	-----------	-------------------	--------

8143

Hand chain blocks

- Professional model made of first-rate materials
- Automatic brake with double pawl system
- Swivel hook with safety latch



Robur
EN13157

8143 1 t

WLL t	L m
1	3

081430010 12 kg
€ 220,00 € 132,00

8143 2 t

WLL t	L m
2	3

081430020 20 kg
€ 320,00 € 192,00

8146C

Lever hoist, compact

- Professional model easy to install and use
- Automatic brake with double pawl system for optimized safety
- Roller bearings for increased smoothness and durability
- Swivel hook with safety latch



*Lightweight,
portable*



Robur
EN13157

8146C 0,25 t

WLL t	L m
0,25	1,5

081460002 2,5 kg
€ 210,00 € 126,00

8146

Lever hoists

- Professional model easy to install and use
- Automatic brake with double pawl system for optimized safety
- Roller bearings for increased smoothness and durability
- Swivel hook with safety latch



Robur
EN13157

8146 0,75 t

WLL t	L m
0,75	1,5

081460008 7 kg
€ 215,00 € 129,00

8146 1,5 t

WLL t	L m
1,5	1,5

081460015 11 kg
€ 315,00 € 189,00

720LC/C3



3 impact sockets for wheel nuts, with polymeric inserts

in plastic case
⊙: 17 - 19 - 21 mm



148x132x44 mm

007200653 800 g
€ 40,50 € 24,30

720/C24



Set of 24 impact sockets, 1/2" female drive, phosphatized, in metal case

N. pieces/Description	Beta N.
15 10-12-13-14-15-16-17-18	720
19-21-22-24-27-30-32 mm	
6 13-17-19-21-22-24 mm	720L
3 17-19-21 mm	720LC



007200904 1,7 kg
€ 439,00 € 263,40

1927B

12"

Reversible impact wrench

- "Pin Clutch" impulse device
- Rubber handle
- Reversible lever
- Three power adjustable screwing positions
- Exhaust through handle

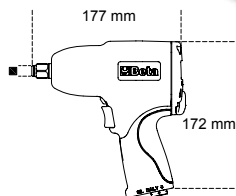

Free speed	rpm	7.000
Impulse device		Pin Clutch
Max. torque	Nm	705
Bolt capacity	Cl 8.8	M22●34 mm
Bolt capacity	Cl 12.9	M18●27 mm
Air inlet	GAS	1/4"
Operating pressure	bar	6,2
Internal hose size (Ø)	mm	10
Mean air consumption	l/min	133

019270022 2,1 kg

€ 226,00 € 135,60

1927XM

12"

Compact reversible impact wrench

- single hammer impulse device
- amazingly compact and powerful
- one-hand reverse button
- three power adjustable screwing positions
- exhaust through handle
- balancing hook

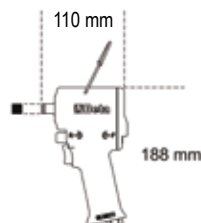

Free speed	rpm	10.000
Impulse device		Single hammer
Max. torque	Nm	770
Bolt capacity	Cl 8.8	M22●34 mm
Bolt capacity	Cl 12.9	M18●27 mm
Air inlet	GAS	1/4"
Operating pressure	bar	6,2
Internal hose size (Ø)	mm	10
Mean air consumption	l/min	122

019270030 1,3 kg

€ 339,00 € 203,40



1927P

12"

Reversible impact wrench

- Double hammer impulse device
- Lightweight and well-balanced for enhanced ease of use
- Reversible lever
- Three power adjustable screwing positions
- Exhaust through handle
- Vibration-damping handle

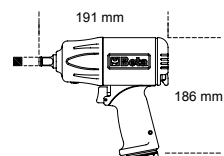

Free speed	rpm	7.500
Impulse device		Double hammer
Max. torque	Nm	1750
Bolt capacity	Cl 8.8	M24●36 mm
Bolt capacity	Cl 12.9	M20●30 mm
Air inlet	GAS	1/4"
Operating pressure	bar	6,2
Internal hose size (Ø)	mm	10
Mean air consumption	l/min	290

019270008 2 kg

€ 545,00 € 327,00



1928XM

3/4"

Compact reversible impact wrench

- Double hammer impulse device
- Amazingly compact and powerful
- One-hand reverse button
- Three power adjustable screwing positions
- Exhaust through handle



1.600 Nm

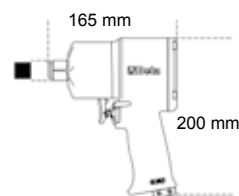

Free speed	rpm	4.800
Impulse device		Double hammer
Max. torque	Nm	1600
Bolt capacity	Cl 8.8	M27●41 mm
Bolt capacity	Cl 12.9	M24●36 mm
Air inlet	GAS	3/8"
Operating pressure	bar	6,2
Internal hose size (Ø)	mm	10
Mean air consumption	l/min	570

019280030 2,9 kg

€ 700,00 € 420,00

- ultra compact
- powerful
- light

7353Y

New item

Mesh fabric shoe, highly breathable, with TPU inserts
 High-visibility reflective mesh upper
 • Carbon fibre toe cap
 • Composite fibre penetration-proof insole

“0-Gravity”

100 grams less for each step walked mean saving approximately 1000 kilos a day and over

200 tons a year!

¹compared to the average weight of a shoe of the same category, size 42



420 g

EU	UK	SKU
38	5	073530038
39	6	073530039
40	6,5	073530040
41	7	073530041
42	8	073530042
43	9	073530043
44	10	073530044
45	10,5	073530045
46	11	073530046
47	12	073530047
48	13	073530048



EN ISO 20345 2011

S1P HRO SRC

~~€ 203,00~~ **€ 121,80**

Beta Collection

9539CB
Cycling Helmet

S/M 95390010
L/XL 95390011

~~€ 230,00~~ **€ 138,00**

9548KB
Balance bike, aluminium frame

95480110

~~€ 172,00~~ **€ 103,20**

7813
Shorts

~~€ 73,00~~ **€ 43,80**

9526RMN
2 packs 55 rummy playing cards

95260001

~~€ 38,00~~ **€ 22,80**

9598W
Mountain Bike

+
FREE

M 095980110
L 095980112

~~€ 1.530,00~~ **€ 918,00**

Size	SKU
S	078130001
M	078130002
L	078130003
XL	078130004
XXL	078130005



Beta Tools (UK) Limited
Unit D - Horton Enterprise Park
Hortonwood 50, Telford
Shropshire, TF1 7GZ
Sales: Tel. (01952) 677977
www.beta-tools.co.uk
sales@beta-tools.com



998015612

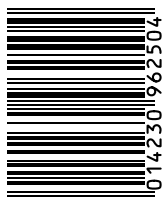

The images are for reference only. Beta Utensili S.p.A. reserves the right to update and upgrade its product range without notice.